

SPACEKAP

THE SOLUTION TO YOUR NEEDS

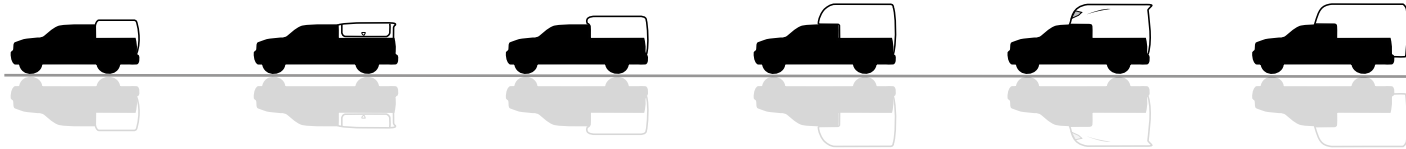

About Spacekap

We have been manufacturing truck caps for recreational and commercial use since 1972. Regardless of the product that you buy from us, we are committed to providing you with a personalized service and quality for both the purchased product and the after-sales service. It is our priority!

Be creative and innovative

Technological innovation plays a key role in the success of new products, the dedication and work of our Research & Development team and its partners guarantee this.

Superiority in products

No compromise is possible when it comes to quality. Therefore, Fibrobec pays meticulous attention to the detail and precision of its products which represent a long tradition of quality.

Entrepreneurial spirit

Fibrobec encourages the efficiency and creativity of its entire team. Positive and dynamic, we encourage personal initiatives and responsibilities to each in a context where only common sense and practicality dominate.

Desire to be the best

This value is to continuously improve, to never be satisfied, to continually improve our abilities and innovate with new ideas. To encourage constant progress in all of its employees, Fibrobec encourages this state of mind.

The Spacekap Concept

The Spacekap concept was not born yesterday. It was developed by the founder of Fibrobec and its engineers more than 35 years ago. From the beginning, it was innovative and even today, is the pride of our team.

The primary goal of this concept was: To make a universal and transferable tool box (no matter what the make of the pick-up truck), lightweight, resistant to humidity and mold and especially resistant to the rigors of the road and its users.

To do so, only the best available materials were and are used. The goal being to use the very best in terms of components, and to this day our Spacekap remains the reference in the industry. Be assured that it will serve you during many years in your projects and endeavors.



Compak

Description

The COMPAK is the innovation awaited by the industry which combines aggressive lines and a low roof line for added access to low area places. With its incorporated side utility doors and its LED lights, the COMPAK will meet and exceed the requirements in a variety of trades within today's market.

Standard characteristics

- Monocoque
- 40/60 rear doors
- Full length side access doors
- 40" LED lightbar incorporated in both side doors
- LED 3rd brake light
- Magnetic switches on all 3 door openings
- 12Volt plug
- Double partition composite walls and roof, no condensation (sandwich construction)
- Stainless steel door hinges
- Compression type handles with double locking capability
- Interior rubber floor mat (1/4" thick)
- Adjustable door retainers
- Extruded HD door sill
- Checker plates in the rear doors
- Access for rear lights of pick-up (8' models only)
- No tool required patented tie down system
- Rapid installation
- Anti-movement installation kit
- Superior white UV resistant gelcoat



	Compak 6	Compak 8
Interior Length	82"	98"
Interior Height	44"	44"
Floor Width	48.25"	48.25"
Rear Opening	52"	52"
Volume	144 cu.ft.	173 cu.ft.
Weight	375 lbs	410 lbs

Options

- Rolling cargo bed
- Spacetube
- Roof mounted ladder/stepladder rack
- Aluminum shelving
- Heavy duty lock
- Automotive quality paint
- MANY OTHERS.....

COMPAK



Diablo

Description

The DIABLO is a unit which possesses the most interior volume in the industry and great aerodynamics at the same time. With natural lighting coming from a skylight configuration in the front section and its 40/60 rear doors, the DIABLO is what others will use as a reference in the industry.

Standard characteristics

- Monocoque
- Skylight configuration in the deck
- 40/60 slamshut rear doors
- 40" LED lightbar
- LED 3rd brake light
- Magnetic switches at the door opening
- 12Volt plug
- Double partition composite walls and roof, no condensation (sandwich construction)
- Stainless steel door hinges
- Integrated rain gutters
- Interior rubber floor mat (1/4" thick)
- Adjustable door retainers
- Extruded HD door sill
- Extruded aluminum top door sill
- Checker plates in the rear doors
- Access for rear lights of pick-up (8' models only)
- No tool required patented tie down system
- Rapid installation
- Anti-movement installation kit
- Superior white UV resistant gelcoat



	Diablo 6	Diablo 8
Interior Length	82"	98"
Interior Height	75"	75"
Floor Width	48.25"	48.25"
Rear Opening	52"	52"
Volume	320 cu.ft.	372 cu.ft.
Weight	600 lbs	650 lbs

Options

- Drop down roof rack for ladder/stapladder
- Side mounted ladder or stepladder rack
- Aluminum shelving
- Workbench
- Locker
- Many ventilation options available
- Heavy duty lock
- Automotive quality paint
- MANY OTHERS.....



Classic

Description

The SpaceKap Classic is the ultimate toolbox whether you're a small contractor or a large fleet operator. The combination of a full-size pickup with a SpaceKap Classic will favourably replace a van as a service truck.

Standard characteristics

- No tool required patented tie down system
- Rapid installation
- Keyed double rear slamshut door system
- Double partition composite walls and roof, no condensation (sandwich construction)
- Double partition composite floor (honeycomb structural material)
- Integrated four corner jack mounting brackets
- 2 Interior lights with automatic mechanism at door opening
- LED 3rd brake light
- Interior rubber floor mat (1/4" thick)
- Stainless steel door hinges
- Anti-slip aluminum doorstep with reflectorized tape
- Checker plates in the rear doors
- Adjustable door retainers
- Interior black rail for anchorage
- Access for rear lights of pick-up (8' models only)
- Superior white UV resistant gelcoat
- Anti-movement installation kit



	Classic 6	Classic 8
Interior Length	82"	98"
Interior Height	56"	56"
Floor Width	48.25"	48.25"
Rear Opening	48.5"	48.5"
Volume	180 cu.ft.	205 cu.ft.
Weight	450 lbs	520 lbs

Options

- Rolling cargo bed
- Spacetube
- Roof mounted ladder/stepladder rack
- Aluminum shelving
- Vice on extension tube
- Fiberglass side utility door
- Heavy duty lock
- Automotive quality paint
- MANY OTHERS.....

CLASSIC



Plus

Description

With a large interior volume and a wide array of accessories available, the SpaceKap Plus can easily be customized to fit your specific requirements. Whether it is used as a mobile office, a toolbox or to carry building materials, the Plus can do it all.

Standard characteristics

- No tool required patented tie down system
- Rapid installation
- Keyed double rear slamshut door system
- Double partition composite walls and roof, no condensation (sandwich construction)
- Double partition composite floor (honeycomb structural material)
- Integrated four corner jack mounting brackets
- 2 Interior lights with automatic mechanism at door opening
- LED 3rd brake light
- Interior rubber floor mat (1/4" thick)
- Stainless steel door hinges
- Anti-slip aluminum doorstep with reflectorized tape
- Checker plates in the rear doors
- Adjustable door retainers
- Interior black rail for anchorage
- Access for rear lights of pick-up (8' models only)
- Superior white UV resistant gelcoat
- Anti-movement installation kit



	Plus 6	Plus 8
Interior Length	82"	98"
Interior Height	72"	75"
Floor Width	48.25"	48.25"
Rear Opening	48.5"	48.5"
Volume	240 cu.ft.	320 cu.ft.
Weight	570 lbs	620 lbs

Options

- Drop down roof rack for ladder/stepladder
- Side mounted ladder or stepladder rack
- Aluminum shelving
- Workbench
- Locker
- Camper side window
- Heavy duty lock
- Automotive quality paint
- MANY OTHERS.....



Somager

Description

The quality and versatility of the SpaceKap system but adapted to mini-pickups with beds in the 6' range. The SpaceKap Somager will fit all domestics and import brands of trucks.

Standard characteristics

- No tool required patented tie down system
- Rapid installation
- Keyed double rear slamshut door system
- Double partition composite walls and roof, no condensation (sandwich construction)
- Double partition composite floor (honeycomb structural material)
- Integrated four corner jack mounting brackets
- 2 Interior lights with automatic mechanism at door opening
- LED 3rd brake light
- Interior rubber floor mat (1/4" thick)
- Stainless steel door hinges
- Anti-slip aluminum doorstep with reflectorized tape
- Checker plates in the rear doors
- Adjustable door retainers
- Interior black rail for anchorage
- Superior white UV resistant gelcoat
- Anti-movement installation kit



Somager

Interior Length	75"
Interior Height	50"
Floor Width	38.25"
Rear Opening	48.5"
Volume	120 cu.ft.
Weight	410 lbs

Options

- Spacetube
- Roof mounted ladder/stapladder rack
- Aluminum shelving
- Vice on extension tube
- Fiberglass side utility door
- Heavy duty lock
- Automotive quality paint
- MANY OTHERS.....

SOMAGER



Max

Description

The SpaceKap Max has been designed to answer the big fleet operator's requests. Ideal for the mobile workshop loaded with all the commodities it offers maximum volume and maximum profitability!

* For equipment intensive applications, the MAX should be used in combination with a 1 ton duallie pickup truck.

Standard characteristics

- No tool required patented tie down system
- Rapid installation
- Keyed double rear slamshut door system
- Double partition composite walls and roof, no condensation (sandwich construction)
- Double partition composite floor (honeycomb structural material)
- Integrated four corner jack mounting brackets
- 2 Interior lights with automatic mechanism at door opening
- LED 3rd brake light
- Interior rubber floor mat (1/4" thick)
- Stainless steel door hinges
- Anti-slip aluminum doorstep with reflectorized tape
- Checker plates in the rear doors
- Adjustable door retainers
- Interior black rail for anchorage
- Access for rear lights of pick-up (8' models only)
- Superior white UV resistant gelcoat
- Anti-movement installation kit
- 48" rear step



Max

Interior Length	122"
Interior Height	75"
Floor Width	48.25"
Rear Opening	48.5"
Volume	410 cu.ft.
Weight	980 lbs

Options

- Drop down roof rack for ladder/stepladder
- Side mounted ladder or stepladder rack
- Aluminum shelving
- Workbench
- Locker
- Many ventilation options available
- Beacon light
- Camper side window
- Heavy duty lock
- Automotive quality paint
- MANY OTHERS.....



Available Packages

We offer below a few packages that we have prepared in cooperation with our supplier and some major clients in the industry. They include the most requested options within their respective trades. Of course, they represent only a very small possibility of the potential of the Spacekap because we can customize according to your needs the interiors. However, it is important to note that in choosing one of these packages as they are proposed to you, you will benefit from a substantial economy.

Compak packages (available for both 6' and 8' beds)

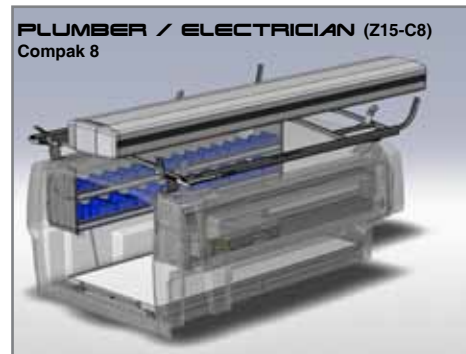
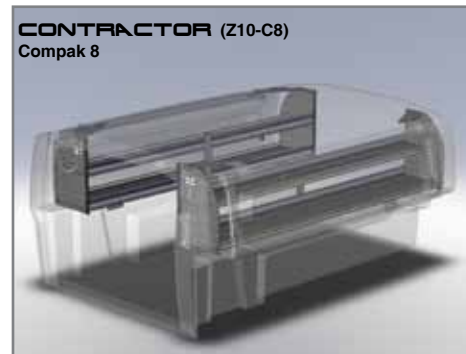

Diablo packages (available for both 6' and 8' beds)

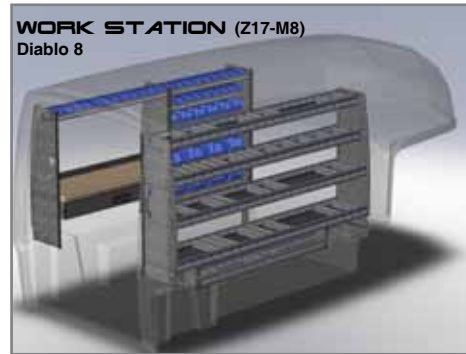
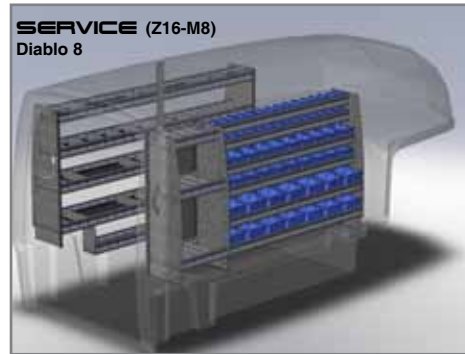
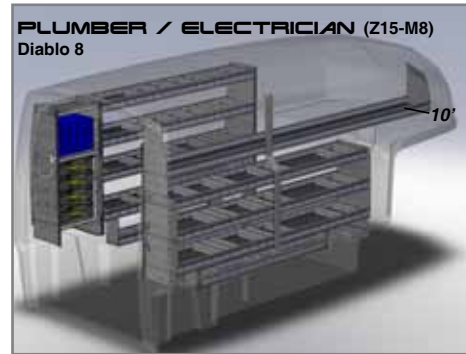
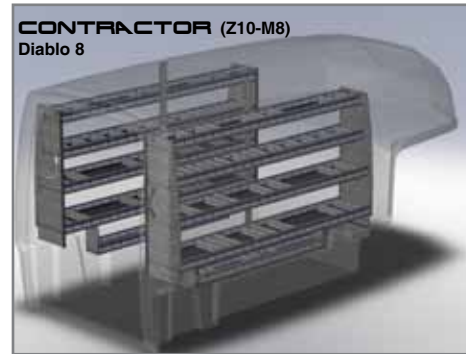

Classic packages (available for both 6' and 8' beds)

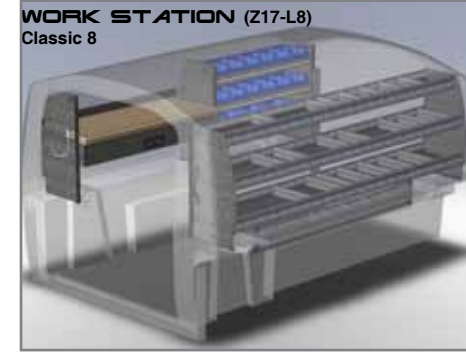
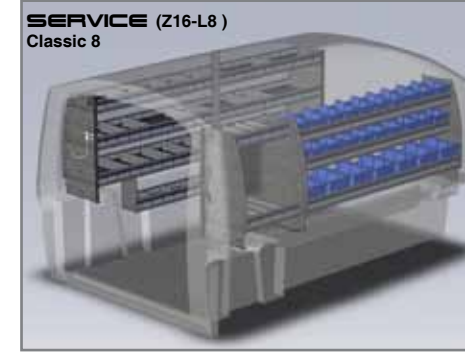
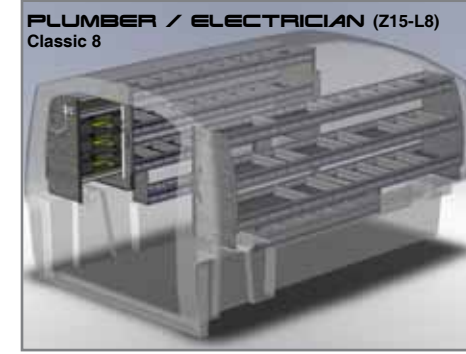
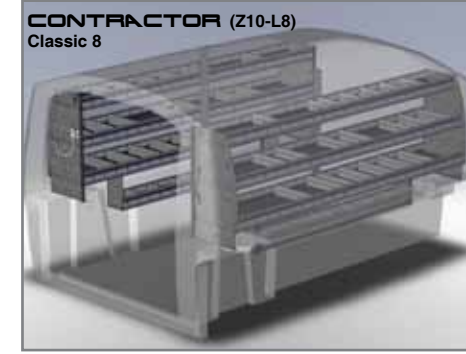

Plus packages (available for both 6' and 8' beds)

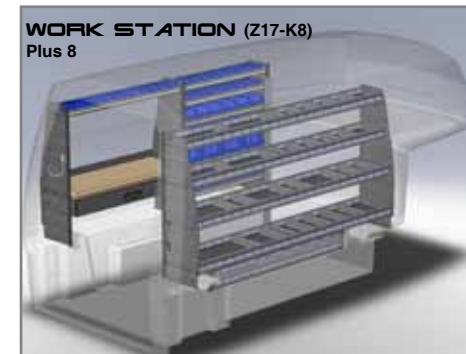
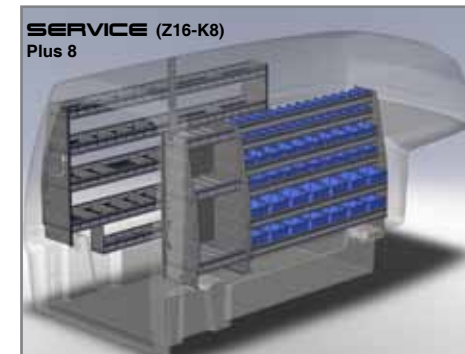
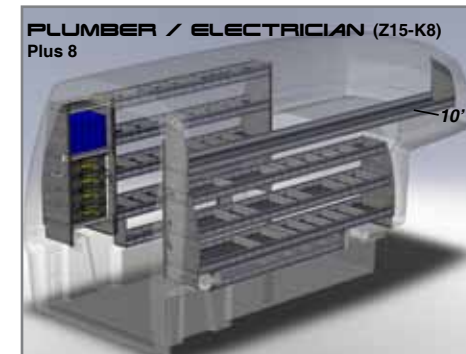
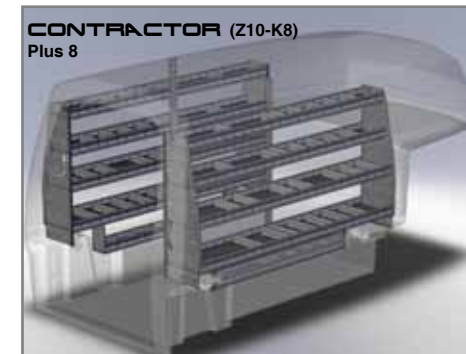

Max packages (same as the Spacekap Plus 8)

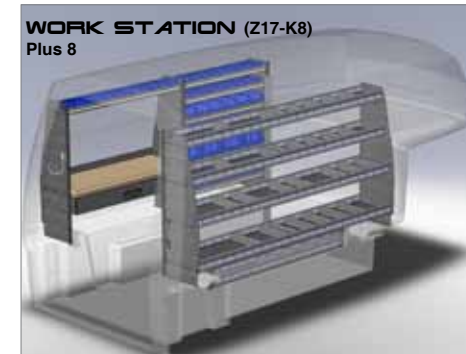
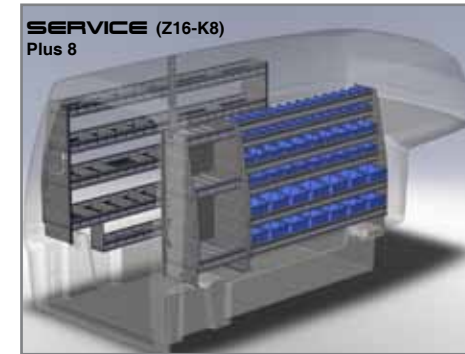
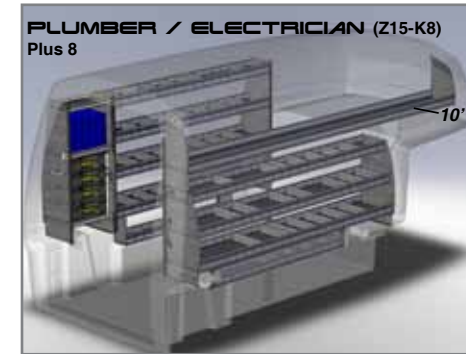
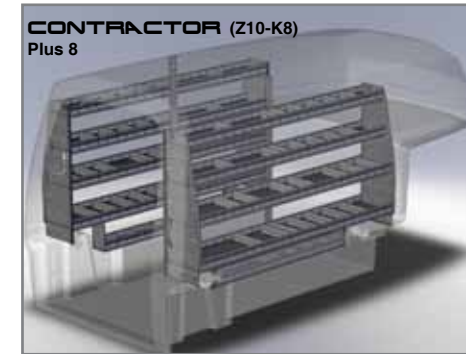

Examples of available options

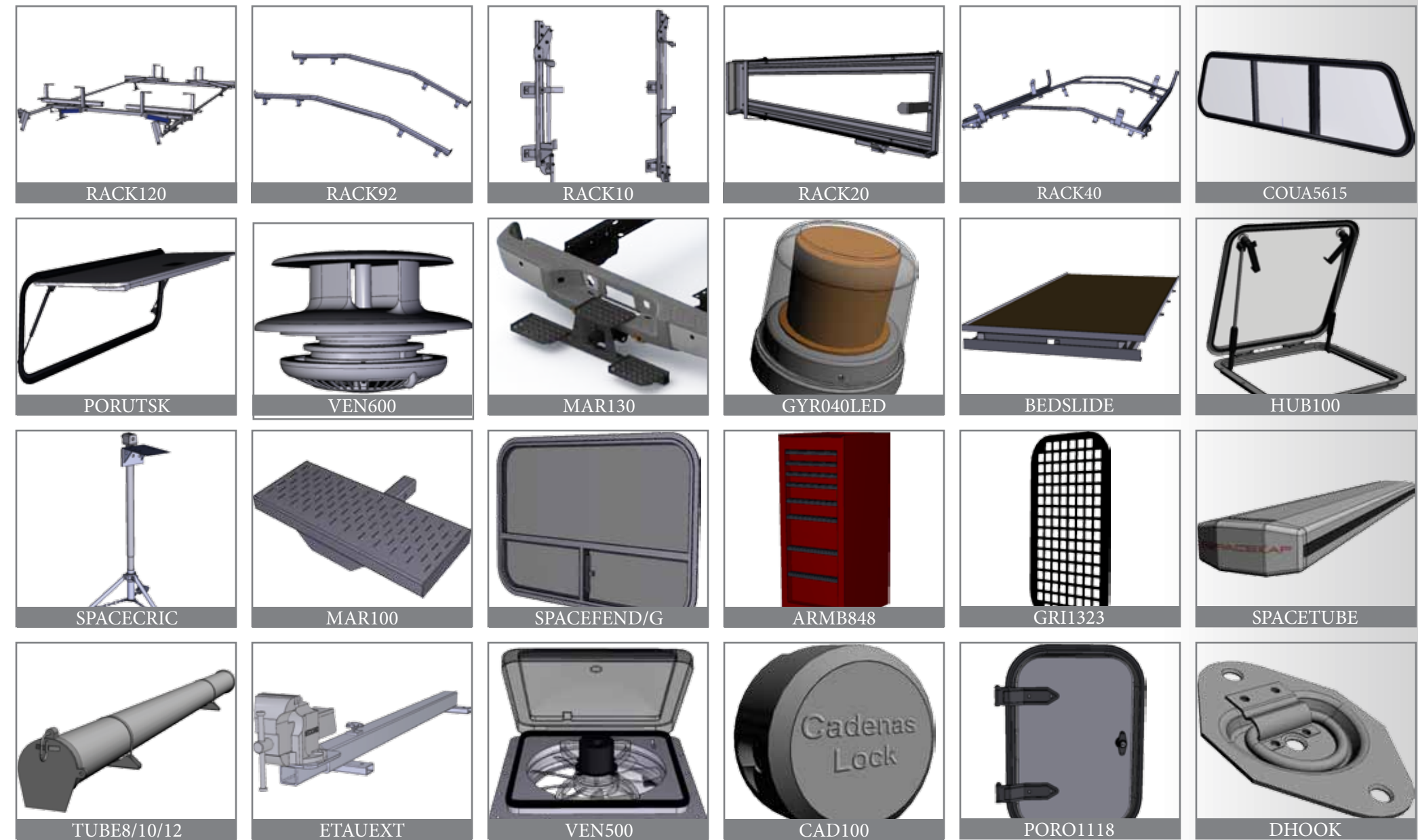

Fit List

		Compak 6	Compak 8	Diablo 6	Diablo 8	Classic 6	Classic 8	Plus 6	Plus 8	Somager	Mid	Max	SpaceKool
	Ram 1500	<input type="checkbox"/>	<input type="checkbox"/>	<input type="checkbox"/>	<input type="checkbox"/>	<input type="checkbox"/>	<input type="checkbox"/>	<input type="checkbox"/>	<input type="checkbox"/>	<input type="checkbox"/>	<input type="checkbox"/>	<input type="checkbox"/>	<input type="checkbox"/>
	Dakota 05+	<input type="checkbox"/>	<input type="checkbox"/>	<input type="checkbox"/>	<input type="checkbox"/>	<input type="checkbox"/>	<input type="checkbox"/>	<input type="checkbox"/>	<input type="checkbox"/>	<input type="checkbox"/>	<input type="checkbox"/>	<input type="checkbox"/>	<input type="checkbox"/>
	F-250/350/450	<input type="checkbox"/>	<input type="checkbox"/>	<input type="checkbox"/>	<input type="checkbox"/>	<input type="checkbox"/>	<input type="checkbox"/>	<input type="checkbox"/>	<input type="checkbox"/>	<input type="checkbox"/>	<input type="checkbox"/>	<input type="checkbox"/>	<input type="checkbox"/>
	F-150	<input type="checkbox"/>	<input type="checkbox"/>	<input type="checkbox"/>	<input type="checkbox"/>	<input type="checkbox"/>	<input type="checkbox"/>	<input type="checkbox"/>	<input type="checkbox"/>	<input type="checkbox"/>	<input type="checkbox"/>	<input type="checkbox"/>	<input type="checkbox"/>
	Ranger	<input type="checkbox"/>	<input type="checkbox"/>	<input type="checkbox"/>	<input type="checkbox"/>	<input type="checkbox"/>	<input type="checkbox"/>	<input type="checkbox"/>	<input type="checkbox"/>	<input type="checkbox"/>	<input type="checkbox"/>	<input type="checkbox"/>	<input type="checkbox"/>
	2500 / 3500	<input type="checkbox"/>	<input type="checkbox"/>	<input type="checkbox"/>	<input type="checkbox"/>	<input type="checkbox"/>	<input type="checkbox"/>	<input type="checkbox"/>	<input type="checkbox"/>	<input type="checkbox"/>	<input type="checkbox"/>	<input type="checkbox"/>	<input type="checkbox"/>
	1500	<input type="checkbox"/>	<input type="checkbox"/>	<input type="checkbox"/>	<input type="checkbox"/>	<input type="checkbox"/>	<input type="checkbox"/>	<input type="checkbox"/>	<input type="checkbox"/>	<input type="checkbox"/>	<input type="checkbox"/>	<input type="checkbox"/>	<input type="checkbox"/>
	S-10 / Sonoma Colorado / Canyon	<input type="checkbox"/>	<input type="checkbox"/>	<input type="checkbox"/>	<input type="checkbox"/>	<input type="checkbox"/>	<input type="checkbox"/>	<input type="checkbox"/>	<input type="checkbox"/>	<input type="checkbox"/>	<input type="checkbox"/>	<input type="checkbox"/>	<input type="checkbox"/>
	"B" Series	<input type="checkbox"/>	<input type="checkbox"/>	<input type="checkbox"/>	<input type="checkbox"/>	<input type="checkbox"/>	<input type="checkbox"/>	<input type="checkbox"/>	<input type="checkbox"/>	<input type="checkbox"/>	<input type="checkbox"/>	<input type="checkbox"/>	<input type="checkbox"/>
	Frontier 04-	<input type="checkbox"/>	<input type="checkbox"/>	<input type="checkbox"/>	<input type="checkbox"/>	<input type="checkbox"/>	<input type="checkbox"/>	<input type="checkbox"/>	<input type="checkbox"/>	<input type="checkbox"/>	<input type="checkbox"/>	<input type="checkbox"/>	<input type="checkbox"/>
	Frontier 05+	<input type="checkbox"/>	<input type="checkbox"/>	<input type="checkbox"/>	<input type="checkbox"/>	<input type="checkbox"/>	<input type="checkbox"/>	<input type="checkbox"/>	<input type="checkbox"/>	<input type="checkbox"/>	<input type="checkbox"/>	<input type="checkbox"/>	<input type="checkbox"/>
	Titan	<input type="checkbox"/>	<input type="checkbox"/>	<input type="checkbox"/>	<input type="checkbox"/>	<input type="checkbox"/>	<input type="checkbox"/>	<input type="checkbox"/>	<input type="checkbox"/>	<input type="checkbox"/>	<input type="checkbox"/>	<input type="checkbox"/>	<input type="checkbox"/>
	Tundra	<input type="checkbox"/>	<input type="checkbox"/>	<input type="checkbox"/>	<input type="checkbox"/>	<input type="checkbox"/>	<input type="checkbox"/>	<input type="checkbox"/>	<input type="checkbox"/>	<input type="checkbox"/>	<input type="checkbox"/>	<input type="checkbox"/>	<input type="checkbox"/>
	Tacoma 04-	<input type="checkbox"/>	<input type="checkbox"/>	<input type="checkbox"/>	<input type="checkbox"/>	<input type="checkbox"/>	<input type="checkbox"/>	<input type="checkbox"/>	<input type="checkbox"/>	<input type="checkbox"/>	<input type="checkbox"/>	<input type="checkbox"/>	<input type="checkbox"/>
	Tacoma 05+	<input type="checkbox"/>	<input type="checkbox"/>	<input type="checkbox"/>	<input type="checkbox"/>	<input type="checkbox"/>	<input type="checkbox"/>	<input type="checkbox"/>	<input type="checkbox"/>	<input type="checkbox"/>	<input type="checkbox"/>	<input type="checkbox"/>	<input type="checkbox"/>

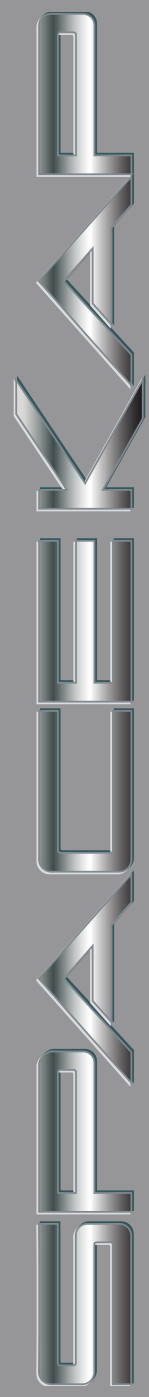

SPACEKAP

219 St-Georges
Beloeil, Québec
J3G 4N4

 800-363-0655

 450-467-1890

SpaceKap and Fibrobec are registered trademarks of Les Industries Fibrobec Inc. This document's illustrations are intended to show the general aspect of the products. The design details may vary according to specific applications. Les Industries Fibrobec Inc. reserves the right to make changes to its product specifications at any time, without prior notice. ©2011 Les Industries Fibrobec Inc.

